

F LEG SUPPORT

The F Leg Support is non-handed. It can be installed on the left or right-hand side of a panel or open frame.

1. Install a clip into the bottommost slots of panel hanger frame with the tabs facing up. (Figure 1)
2. Align threaded inserts on the F Leg Support bottom with the clip. Loosely fasten with two bellville washers - concave side down and 5/16 x 1" cap screws.
3. Position second clip at the top back side of the leg. Install into the slotted hanger frame with the tab's going down. Fasten clip to leg with two bellville washers - concave side down and 5/16" cap screws. **IMPORTANT - DO NOT tighten screws more than 200 in-lbs.** (Figure 2)

Note: A Surface B Support Bracket is required for mounting a surface. The mounting hardware on the surface may have to be adjusted for proper alignment.

F Leg Support Hardware Pack - FLEGHP (#93063001)

F Leg Support Mounting Clip Hdw. Pk. - #99010503-finish

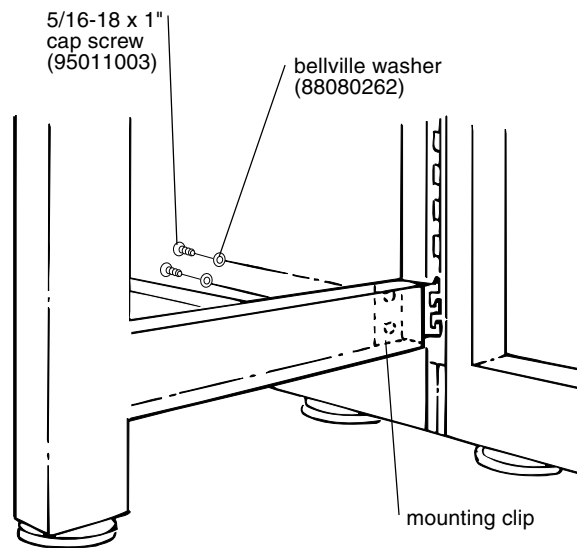

Figure 1

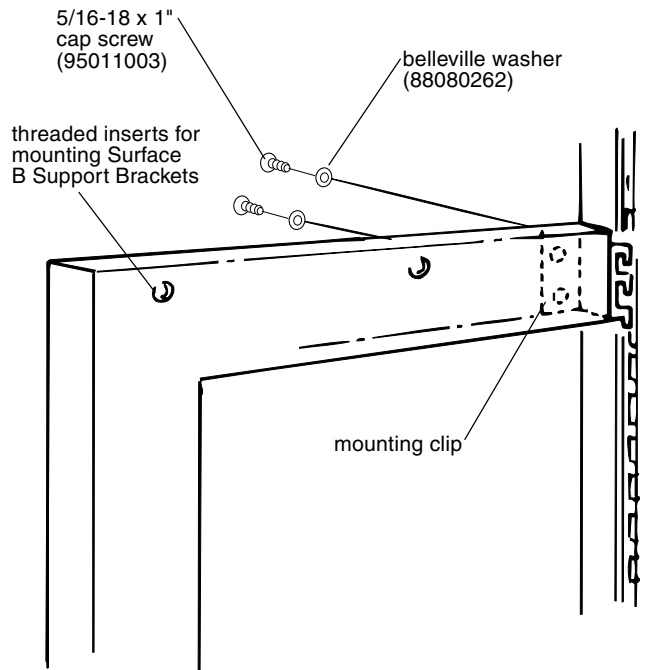

Figure 2