

## TASK LIGHT LENS

The lens have been packaged separately to avoid damage in shipping. Install the lens into the light before installing the Task Light on the station.

1. Lay Task Light upside down on clean surface.

### To Install Parabolic Lens - illustrated

**Note:** DO NOT TOUCH the silver eggcrate area of the lens with unprotected hands. Wear gloves when handling and installing the parabolic lens.

2. With lens perimeter flanges facing down and the eggcrate area facing up, insert flange under back lip of the Task Light. (Figure 1)
3. Push lens to rear. Gently insert front flange of lens under the front lip of the Task Light. (Figure 2)
4. To secure lens in light, engage six (6) spring clips on front and rear flange at each corner and middle of Task Light.

**Parabolic Lens Hardware Pack - PLENHP (#92050402)**

### To Install Batwing Lens

5. With rough side of the lens facing the lamps, insert flange under back lip of Task Light.
6. Push lens to rear. Gently insert front flange of lens under the front lip of Task Light.
7. Install Task Light on station as required.

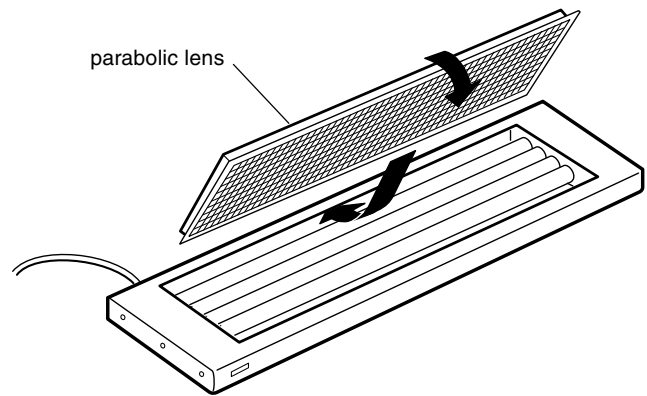

Figure 1

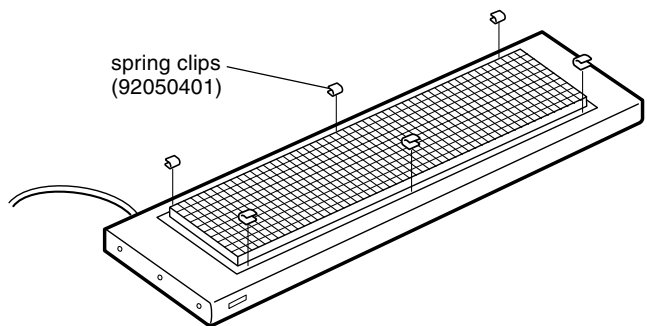

Figure 2